

Silicon Epitaxial Planar Switching Diode

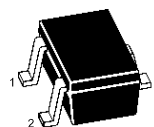
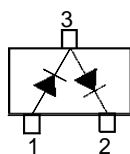

SOT-323 Plastic Package

Absolute Maximum Ratings ($T_a = 25\text{ }^\circ\text{C}$)

Parameter	Symbol	Value	Unit
Repetitive Peak Reverse Voltage	V_{RRM}	85	V
Reverse Voltage	V_R	75	V
Continuous Forward Current	I_F	150	mA
Single Diode Load Double Diode Load		130	
Repetitive Peak Forward Current	I_{FRM}	500	mA
Non-Repetitive Peak Forward Surge Current	I_{FSM}	4	A
at $t = 1\text{ }\mu\text{s}$		1	
at $t = 1\text{ ms}$ at $t = 1\text{ s}$		0.5	
Total Power Dissipation	P_{tot}	200	mW
Thermal Resistance from Junction to Ambient	$R_{\theta JA}$	625	$^\circ\text{C/W}$
Junction Temperature	T_j	150	$^\circ\text{C}$
Storage Temperature Range	T_{stg}	- 55 to + 150	$^\circ\text{C}$

Characteristics at $T_a = 25\text{ }^\circ\text{C}$

Parameter	Symbol	Max.	Unit
Forward Voltage at $I_F = 1\text{ mA}$ at $I_F = 10\text{ mA}$ at $I_F = 50\text{ mA}$ at $I_F = 150\text{ mA}$	V_F	0.715	V
		0.855	
		1	
		1.25	
Reverse Current at $V_R = 25\text{ V}$ at $V_R = 75\text{ V}$ at $V_R = 25\text{ V}, T_j = 150\text{ }^\circ\text{C}$ at $V_R = 75\text{ V}, T_j = 150\text{ }^\circ\text{C}$	I_R	30	nA
		1	μA
		30	μA
		50	μA
Diode Capacitance at $V_R = 0, f = 1\text{ MHz}$	C_d	1.5	pF
Reverse Recovery Time at $I_F = I_R = 10\text{ mA}, I_{tr} = 0.1 \times I_R, R_L = 100\text{ }\Omega$	t_{rr}	4	ns

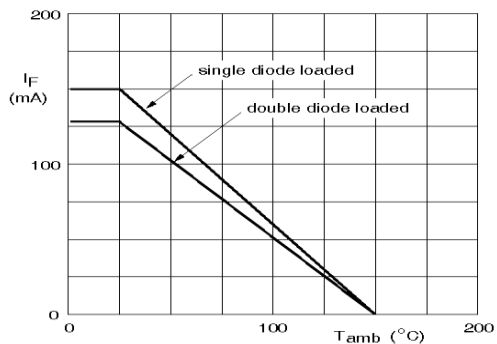

Device mounted on an FR4 printed-circuit board.

Maximum permissible continuous forward current as a function of ambient temperature.

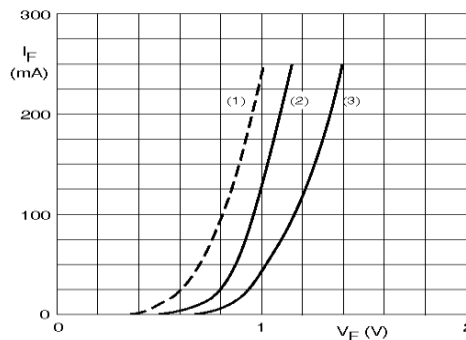

- (1) $T_j = 150^\circ\text{C}$; typical values.
- (2) $T_j = 25^\circ\text{C}$; typical values.
- (3) $T_j = 25^\circ\text{C}$; maximum values.

Forward current as a function of forward voltage.

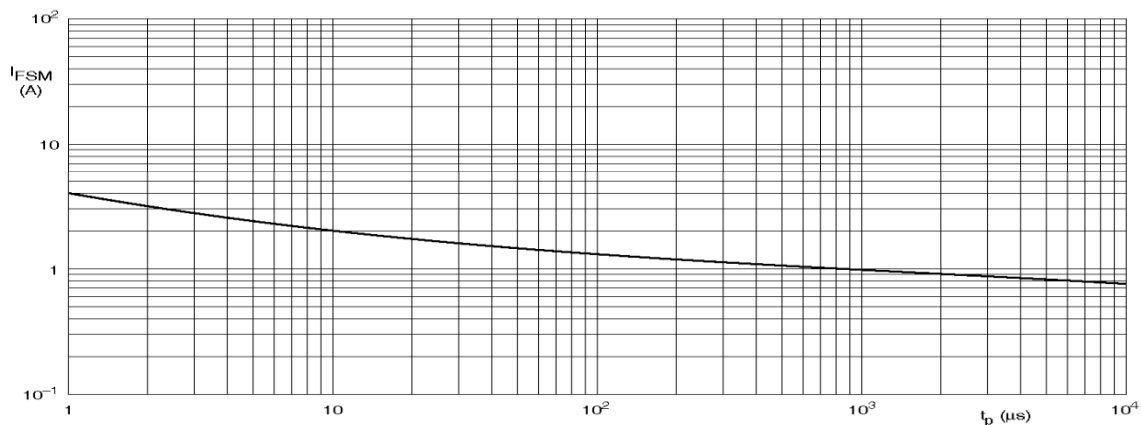

Based on square wave currents.
 $T_j = 25^\circ\text{C}$ prior to surge.

Maximum permissible non-repetitive peak forward current as a function of pulse duration.

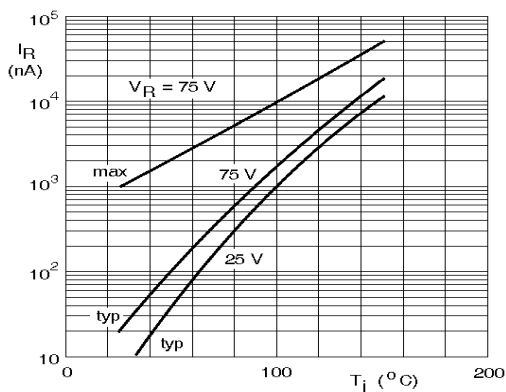

Reverse current as a function of junction temperature.

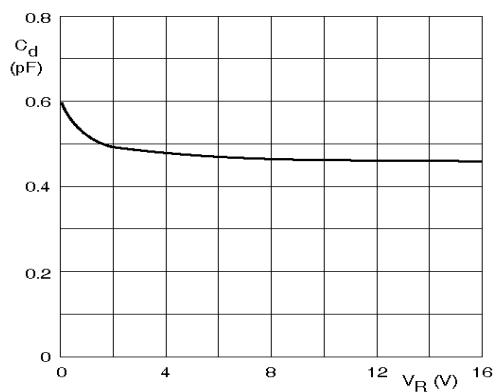

$f = 1\text{ MHz}$; $T_j = 25^\circ\text{C}$.

Diode capacitance as a function of reverse voltage; typical values.

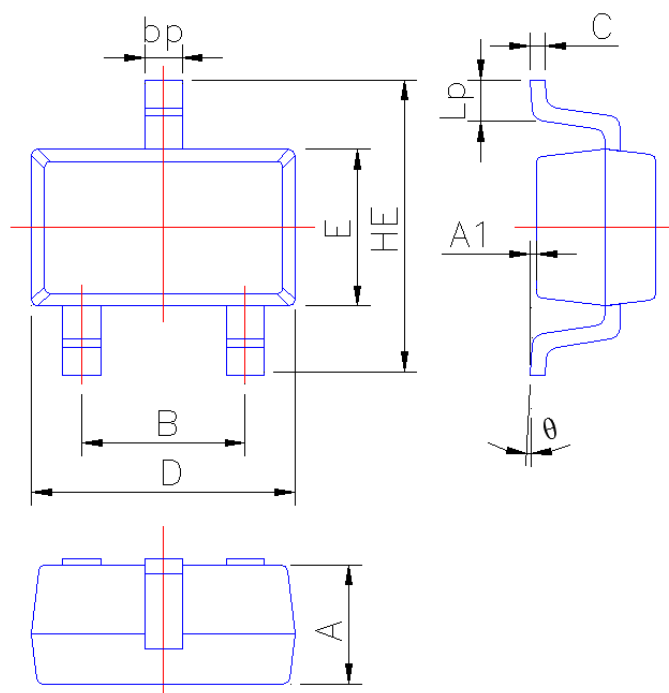
SOT-323 Package Outline Dimensions

Symbol	Dimension in Millimeters	
	Min	Max
A	0.90	1.00
A1	0.010	0.100
B	1.20	1.40
bp	0.25	0.45
C	0.09	0.15
D	2.00	2.20
E	1.15	1.35
HE	2.15	2.55
Lp	0.25	0.46
θ	0°	6°